

POMPE PER VUOTO A PALETTE LUBRIFICATE

Rotary vane vacuum pumps



MVO-300

in partnership with



La realizzazione in conformità con le certificazioni ISO 9001 e CE garantisce la qualità della pompa per vuoto. Le ridotte vibrazioni e la bassa rumorosità ne consentono l'uso in ogni ambiente.

The realization according to the ISO 9001 and CE Certificates guarantees the high quality of the vacuum pump. Low vibration and low noise allow the usage in any environment.

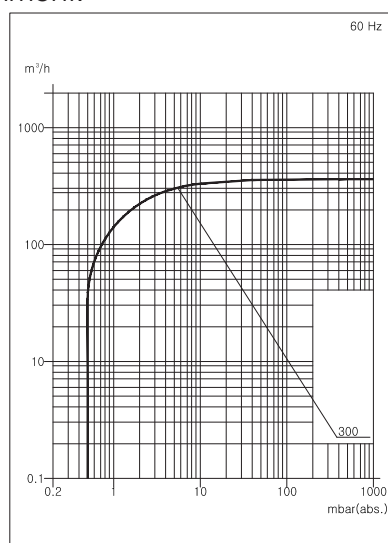
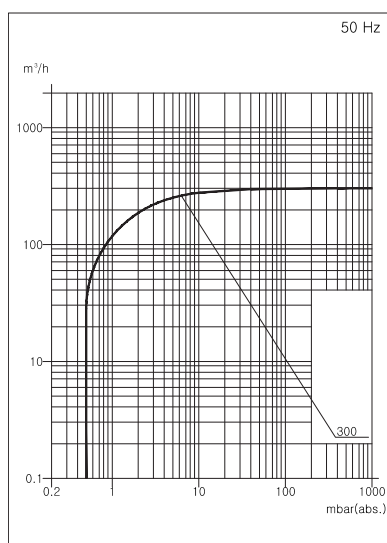

DATI TECNICI / Technical Data	50 Hz	60 Hz
Portata nominale / Nominal displacement	300 m ³ /h	360 m ³ /h
Vuoto finale / Ultimate vacuum	0.5 mbar	0.5 mbar
Tensione motore trifase / Motor tension (3-Ph)	230/400 V	220/380 V
Tensione motore monofase / Motor tension (1-Ph)		
Potenza motore trifase / Motor power (3-Ph)	7.5 kW	7.5 kW
Potenza motore monofase / Motor power (1-Ph)		
Giri motore / Motor speed	1455 min ⁻¹	1755 min ⁻¹
Rumorosità / Sound level	74 dB (A)	76 dB (A)
Tolleranza massima vapore acqueo / Water vapour tolerance max	40 mbar	40 mbar
Capacità vapore acqueo / Water vapour capacity	14 l/h	14 l/h
Temperatura di esercizio / Operating temperature	85 °C	85 °C
Carica olio / Oil filling	7 liter	7 liter
Peso / Weight	218 kg	218 kg

Eurova

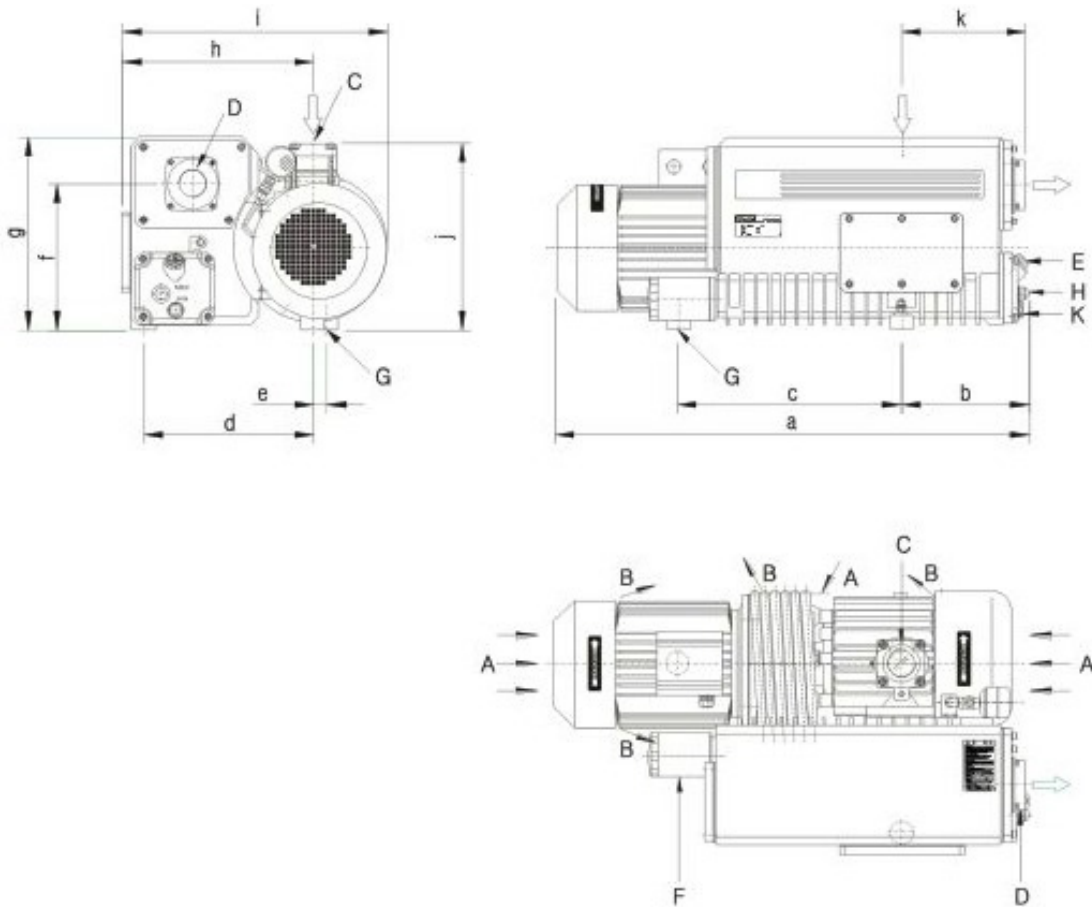

A	Ingresso aria di raffreddamento	Cooling air entry	
B	Uscita aria di raffreddamento	Cooling air exit	
C	Ingresso aria	Inlet flange	PT 2" / NPT 2"
D	Scarico aria	Exhaust port	PT 2" / NPT 2"
E	Tappo di carico olio	Oil filling plug	
F	Filtro olio	Oil filter	
G	Piedino di gomma	Rubber foot	3-M10 (DP 7)
H	Spia visiva	Oil sight glass	
K	Tappo di scarico dell'olio	Oil drain cap	

MODELLO Model	a	b	c	d	e	f	g	h	i	j	k	l
MVO-300	1178	333	485	365	31	339	490	432	605	431	333	